

ALLIED FILTER SYSTEMS LTD RECOGNISES ENVIRONMENTAL MANAGEMENT AS AMONG THE HIGHEST PRIORITIES WITHIN THE BUSINESS.

Our working practices minimise waste generation and resource consumption to safeguard the environment. We continually assess and improve the environmental

impacts of our business and work with our suppliers and customers to help develop more environmentally friendly processes and products.

There are no implied warranties, including the implied warranty of merchantability and fitness for a particular purpose not specific herein respecting this agreement or the product being sold here under or the service provided herein.

This brochure has been printed on paper manufactured from renewable timber, produced on a fully sustainable basis and is suitable for recycling. The pulp used in this paper has been bleached by an elemental chlorine free process (ECF).



3 UK manufacturing sites and Sales Offices in the UK, France, Sweden and Singapore.

HEAD OFFICE

Huntsman Drive, Northbank Industrial Park, Irlam, Manchester, M44 5EG

Tel: +44 (0) 161 777 9500, Fax: +44 (0) 161 777 9506

E: sales@alliedfilter.co.uk



FM 36648



www.alliedfilter.co.uk

Visit us for the most up-to-date product, services and company information.
www.alliedfilter.se / www.alliedfilter.fr / www.alliedfilter.sg



FILTER CARTRIDGES

TABLE OF CONTENTS

- 2** INTRODUCTION AND CENTRE CORES
- 3** STANDARD END CAPS
- 4** WOUND
- 6** MELT BLOWN PROXIS T, A
- 8** MELT BLOWN PROXIS HF, N
- 10** HC SERIES
- 11** RESIN BONDED
- 12** PAINT PACK
- 14** PLEATED
- 16** HIGH FLOW PLEATED
- 18** MULTIFINE
- 19** PES MEMBRANE
- 20** CARBON
- 22** OIL ABSORBENT
- 23** METALLIC

CARTRIDGE FILTERS & VESSELS

ALLIED FILTER SYSTEMS LTD OFFERS A RANGE OF HIGH QUALITY CARTRIDGE FILTERS AND VESSELS FOR PROCESS INDUSTRIES. TYPICAL APPLICATIONS INCLUDE FILTRATION OF WATER, CHEMICALS, PAINTS AND COATINGS, FOOD, BEVERAGES, PETROCHEMICALS AND PHARMACEUTICALS.

Cartridge filters are one of the most widely used technologies for filtration of liquids and gases. They can either be used on their own, or as final filters in conjunction with other methods of liquid filtration such as bag filters.

Selecting the correct cartridge filter and system size is essential to optimize the performance of your filtration system. When making a recommendation, we will consider all the required process parameters such as the amount, type and size of particles to be removed, the fluid flow rate, chemical and temperature compatibility with the filter, fluid viscosity and the permitted pressure drop across the filtration system.

Filter cartridges can be used for applications which require a particle size retention rating of 150 micron and lower and especially for processes which require sub-micron particle retention.

They are typically used for processes where the contaminant levels are in the range of < 1 to 100ppm (0.0001% - 0.01%) for continuous flow applications and up to 1000 ppm (0.1%) for smaller batch size operations.

Allied Filter Systems Ltd. has been at the forefront of the liquid filtration industry for several decades. We are able to draw upon many years of expertise and experience to provide our clients with industry leading technical advice and recommendations, as well as providing exceptional service and account management. We look forward to discussing your filtration needs.

CENTRE CORES

Many cartridges are fitted with a centre core to provide mechanical stability for the filter media, whilst the large open area does not restrict the flow. Cores are available in a variety of materials and designs in accordance with the needs of your application.

SEAM WELDED PERFORATED CORE

POLYPROPYLENE CORE

SPIRAL CORE



STANDARD END CAPS

ALL FILTER CARTRIDGES ARE OFFERED WITH A RANGE OF INDUSTRY STANDARD END CAPS. THEY ARE COMPATIBLE WITH EXISTING FILTER HOUSINGS AS WELL AS NEW INSTALLATIONS FOR WHICH WE ARE ABLE TO RECOMMEND THE MOST SUITABLE CONFIGURATION FOR YOUR APPLICATION.



DOUBLE OPEN ENDED

Can be supplied with or without flat seals

CODE 3

2 x 222
O-rings/flat

CODE 7

2 x 226
O-rings with locking lugs/spear

CODE 8

2 x 222
O-rings/spear

OTHER INDUSTRY STANDARD END CAP FITTINGS ARE AVAILABLE ON REQUEST.



ALL FILTER CARTRIDGES ARE MANUFACTURED TO ISO9001 QUALITY STANDARDS.

WOUND FILTER CARTRIDGES



WOUND FILTER CARTRIDGES ARE ECONOMICAL, NOMINAL RATED DEPTH FILTERS.

They are produced from a continuous fibre yarn spirally wound around a central support core.

The computer controlled winding pattern ensures precise, reliable and repeatable particle removal performance. Wound filters feature a graded density construction, enabling progressively smaller particles to be captured through the depth of the filter media. The result is a high dirt holding capacity filter which has a low pressure drop.

Wound cartridges are most commonly made from polypropylene yarn wound on to a polypropylene core, but for applications where chemical compatibility or operating temperature restricts the use of polypropylene, other fibres such as cotton, glass, polyester, nylon or polyphenylene sulphide (Ryton) can be offered wound on to a stainless steel core. We also offer the option of a glass reinforced polypropylene core which provides superior strength and permits higher operating temperatures (up to 100°C)

- Available in a wide range of micron ratings from 0.5 – 150.
- Standard length: 4 7/8" to 40".
- Custom lengths up to 60" possible.
- Standard diameter: I.D. 27.5mm, O.D. 62mm.
- Available in large 110mm diameter, 10" and 20" lengths for higher flow rates and dirt holding capacity.
- Most commonly double open ended, but can be fitted with all industry standard end caps.

- O-rings for end caps include Nitrile, EPDM, Silicone, Viton, PTFE encapsulated viton, PTFE encapsulated silicone.
- Washed or fibrillated polypropylene also available for sensitive applications.
- Maximum recommended differential pressure: 2.5 Bar.



PRESSURE DROP DATA OBTAINED USING WATER AT 20°C PER 10" FILTER

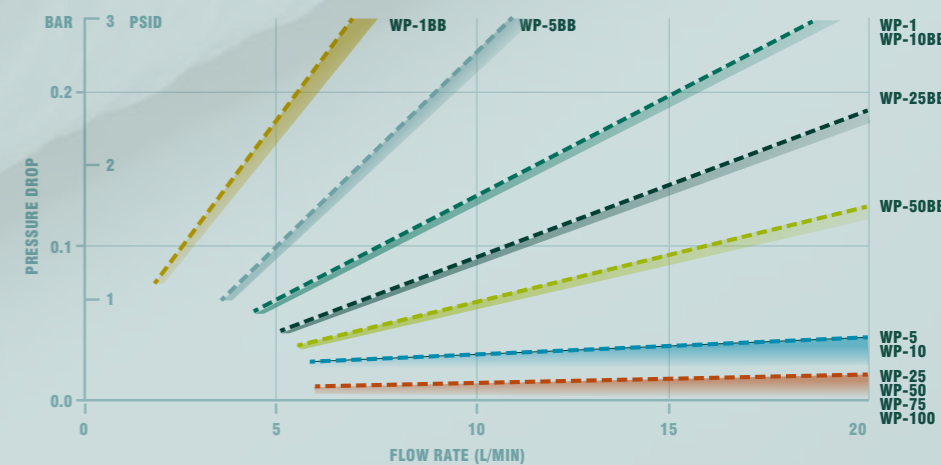

HIGH DIRT HOLDING CAPACITY FILTERS WITH A LOW PRESSURE DROP.



WOUND FILTERS ARE PRODUCED FROM A CONTINUOUS FIBRE YARN SPIRALLY WOUND AROUND A CENTRAL SUPPORT CORE.

MELT BLOWN CARTRIDGES

PROXIS T & PROXIS A SERIES

Proxis T series cartridges are nominal rated with a particle removal efficiency of 90% at the designated micron rating.

Proxis A series cartridges are absolute rated with a particle removal efficiency of 99.9% at the designated micron rating.

Proxis T and Proxis A cartridges have a 100% polypropylene construction, and feature an inner core to enhance mechanical strength. They have a graded density structure, and have no contaminant downloading even at high differential pressures.

- Available in a wide range of micron ratings from 0.5 – 150.
- Standard length: 4 7/8" to 40".
- Custom lengths up to 60" possible.
- Standard diameter: I.D. 27.5mm, O.D. 63.5mm.
- Available in large 110mm diameter, 10" and 20" lengths for higher flow rates and dirt holding capacity.
- Can be fitted with all industry standard end caps.
- O-rings for end caps include Nitrile, EPDM, Silicone, Viton, PTFE encapsulated Viton, PTFE encapsulated Silicone.
- Maximum recommended differential pressure: 2.6 Bar (1 Bar @ 82°C, 2 Bar @ 66°C, 4.2 Bar @ 24°C).
- Maximum recommended temperatures: 59°C – double open ended versions
82°C – all single open ended versions.

- Cartridges will easily rinse-up to 18 Megohm-cm.
- Toxicity: Cartridges are appropriate for use in pharmaceutical applications. Components meet USP-XXIII, Class VI criteria.
- Purity: Proxis cartridges are made from polypropylene resin meeting FDA regulation 21 CFR 177.1520. No binders, lubricants or anti-static agents are used in the manufacturing process.

PROXIS CARTRIDGES CAN BE FITTED WITH ALL INDUSTRY STANDARD END CAPS.

PROXIS T

FLOW RATE VS DIFFERENTIAL PRESSURE FOR PROXIS T CARTRIDGES. PRESSURE DROP INCLUDES THAT DUE TO THE FILTER HOUSING.

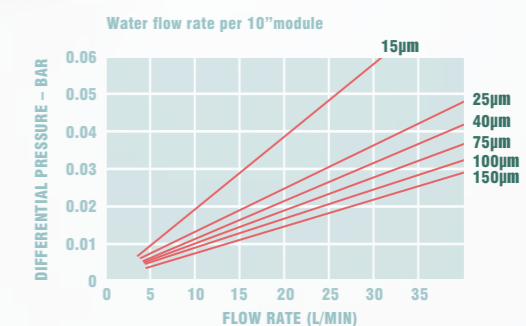
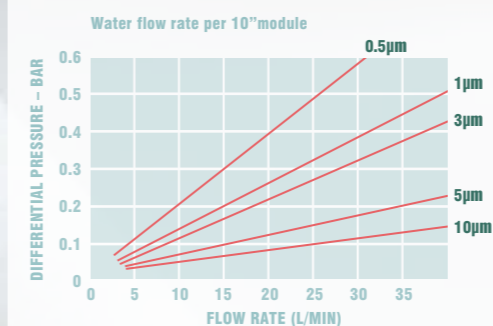

PROXIS A

FLOW RATE VS DIFFERENTIAL PRESSURE FOR PROXIS A CARTRIDGES. PRESSURE DROP INCLUDES THAT DUE TO THE FILTER HOUSING.

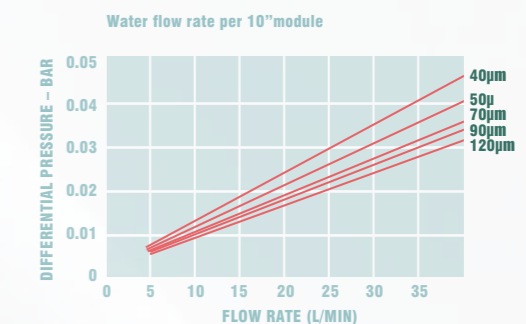
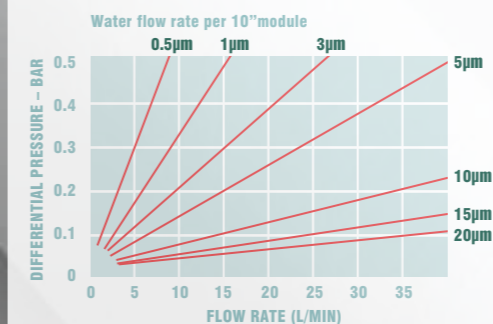

GRADED DENSITY STRUCTURE WITH NO CONTAMINANT DOWNLOADING EVEN AT HIGH DIFFERENTIAL PRESSURES.



ALL FILTER CARTRIDGES ARE MANUFACTURED TO ISO9001 QUALITY STANDARDS.

PROXIS

HF SERIES

Proxis HF are designed to perform depth filtration whilst handling a high flow-rate.

They feature a two zone filtration structure where a pre-filter and final filter are combined in a single element.

The large internal diameter minimizes differential pressure and consequently a reduced number of elements compared to using conventionally sized cartridges is required for large flow rate applications. Therefore the required filter housing will be smaller, reducing capital investment. For example, 40" Proxis HF cartridges can handle flow rates of 300 -800 L/min depending on micron rating and permitted pressure drop.

Proxis HF cartridges are "coreless" filter elements, and mechanical strength is provided by an internal perforated tube located within the filter housing.

- 100% polypropylene construction.
- Available micron ratings 1, 5, 10, 20, 40.
- Dimensions : 114.3mm I.D. x 152.4mm O.D.
- Length : 20" or 40".
- Max differential pressure: 4.2 Bar at 20°C.
- Max temperature: 60°C.

TWO ZONE FILTRATION STRUCTURE WHERE A PRE-FILTER AND FINAL FILTER ARE COMBINED IN A SINGLE ELEMENT

PROXIS

N SERIES



PROXIS N SERIES CARTRIDGES ARE NOMINAL RATED WITH A PARTICLE REMOVAL EFFICIENCY OF 95% AT THE DESIGNATED MICRON RATING.

Manufactured from 100% Nylon fibres, they are ideally suited to applications such as filtration of solvents, solvent based paints and coatings and petrochemicals. They are not recommended for use with water based products.

- Available in a wide range of micron ratings from 1 – 200.
- Standard length: 9 3/4" to 40".
- Standard diameter: I.D. 28mm, O.D. 64mm.
- Inner core options: Nylon, Tinned Steel, Stainless Steel 316.
- Most commonly double open ended, but can be fitted with several industry standard end caps.
- O-rings for end caps include Nitrile, EPDM, Silicone, Viton, PTFE encapsulated Viton, PTFE encapsulated Silicone.

MAXIMUM OPERATING CONDITIONS

OPERATING TEMPERATURE	MAXIMUM RECOMMENDED ΔP	
	STEEL CORE	NYLON CORE
20°C	4.0 Bar	4.0 Bar
50°C	4.0 Bar	3.0 Bar
80°C	4.0 Bar	1.0 Bar
150°C	4.0 Bar	0.5 Bar

FLOW RATE VS DIFFERENTIAL PRESSURE FOR PROXIS N SERIES - PER 10" CARTRIDGE.

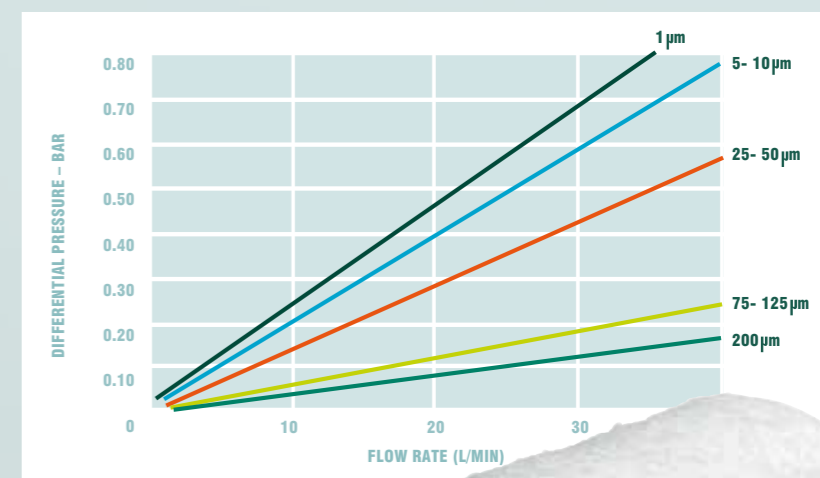

HC SERIES CARTRIDGES

WHILST MOST MELT BLOWN CARTRIDGES ARE USED FOR CLARIFICATION OF FLUIDS, THE HC SERIES IS A DEPTH FILTER WHICH IS USED FOR PARTICLE SIZE CLASSIFICATION.

The construction incorporates rigid support materials which prevent media deformation under high differential pressures, providing stable performance and flow rates. The graded density polypropylene media ensures a long service life.

The HC series is especially widely used for the filtration of paints and coatings and with fluids which have a high viscosity.

- Available micron ratings: 0.5 to 400.
- Available lengths: 5" – 20"
- Inner diameter 27mm. Outer diameter 67mm.
- With polypropylene support core
- Double open ended with polyethylene gaskets
- Maximum differential pressure: 4.9 Bar @ 20°C.
- Maximum operating temperature: 60°C.



RESIN BONDED FILTER CARTRIDGES

RESIN BONDED FILTER CARTRIDGES ARE LOW COST, NOMINAL RATED DEPTH FILTERS.
Most common applications include :

- Filtration of fluids with a high viscosity.
- Filtration of solvents, including solvent based paints.
- Processes requiring a high operating temperature.
- Processes permitting a high differential pressure across the filter.

Resin bonded cartridges are manufactured from long acrylic fibres which provide superior cartridge strength and resist breakage. Phenolic resin impregnation also enhances the strength of the cartridge structure and eliminates the need for a support core.

Resin Bonded filter cartridges feature a unique two-stage filtration design to maximise particle retention and service life. The outer spiral wrap collects large particles and agglomerates, whilst the inner layers control the removal of smaller particles.

- Available in a wide range of micron ratings from 2 – 150.
- Standard length: 9 7/8" to 40".
- Standard diameter: I.D. 28.6mm, O.D. 65mm.
- Double open ended configuration.
- Maximum recommended operating temperature 121°C.
- Recommended change out differential pressure 3.5 Bar. See table below for maximum cartridge pressure resistance.



FLUID: CMC (400cP)
CARTRIDGE LENGTH: 250mm

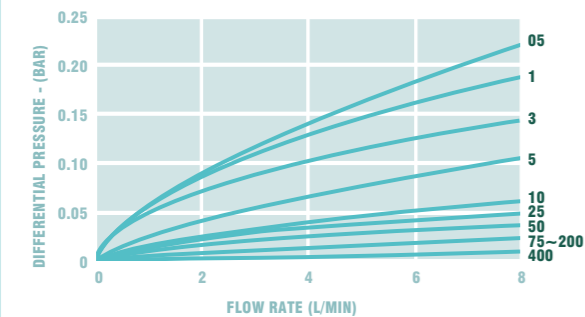

The data does not include piping pressure drop

FLUID: CMC (10,000cP)
CARTRIDGE LENGTH: 250mm

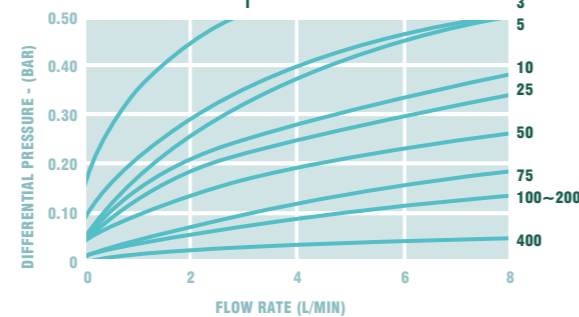

The data does not include piping pressure drop

PARTICLE SIZE (µm)	PARTICLE REMOVAL EFFICIENCY (%) BY FILTER GRADE												
	05	1	3	5	10	25	50	75	100	150	200	400	
3	>75												
5	>90	>90	>80										
10	>99.9	>99.9	>98	>90									
25			>99.9	>99.9	>98	>90	>80						
50					>99.9	>99.9	>99.9	>90					
75								>98	>90	>80			
100								>99.9	>98	>90	>80	>75	
150									>99.9	>99.9	>98	>90	
200											>99.9	>95	

TEMPERATURE (°C)	CARTRIDGE PRESSURE RESISTANCE (BAR)
21	10
38	8.6
65	6.2
82	4.5
121	1.7

PHENOLIC RESIN IMPREGNATION ENHANCES THE STRENGTH OF THE CARTRIDGE STRUCTURE AND ELIMINATES THE NEED FOR A SUPPORT CORE.

VERSATILE, LOW COST FILTER CARTRIDGE IDEAL FOR FILTRATION OF HIGH VISCOSITY FLUIDS AND SOLVENT BASED FLUIDS.

PAINT PACK

CARTRIDGE FILTER SYSTEM

THE INNOVATIVE PAINT PACK CARTRIDGE FILTER SYSTEM IS AN ENCLOSED CARTRIDGE FILTER UNIT WITHIN A SEALED OUTER BAG. WHILST IT IS MOST COMMONLY USED IN THE PAINT INDUSTRY, IT IS SUITABLE FOR MANY APPLICATIONS WHICH DESIRE AN ENCLOSED, READY TO USE UNIT FOR REASONS OF USER SAFETY, CLEANLINESS, HYGIENE AND TOXICITY.

The system consists of Polypropylene adaptor with manifold, inlet and outlet ports and a double layered protective bag with filter cartridges located inside. Due to the protective bag, the liquid being filtered does not come into contact with the housing and protects the user from direct contact with the fluid during filter changeout.

The Paint Pack Cartridge filter system is manufactured with 1, 3 or 7 filter cartridges and in lengths of 5" to 30" and can be equipped with different types of cartridges in accordance with suitability to the application.

- Adaptor: Polypropylene.
- Protective bag: Polyethylene or Nylon.

- Filter media: CP2 Two zone Polypropylene Depth filter or CP Polypropylene/Polyethylene nominal depth filter.
- Maximum temperature: 60°C.
- Maximum Differential Pressure: 3 Bar @ 20°C.

DIMENSIONS	SINGLE CARTRIDGE	3 CARTRIDGES	7 CARTRIDGES
OUTSIDE DIAMETER	91mm	173mm	236mm
LENGTH: 5" CARTRIDGES	190mm	N/A	N/A
LENGTH: 10" CARTRIDGES	316mm	343mm	371mm
LENGTH: 20" CARTRIDGES	566mm	593mm	621mm
LENGTH: 30" CARTRIDGES	N/A	843mm	871mm
INLET AND OUTLET CONNECTIONS	R ½"	R 1"	R 1 ¼"



DOUBLE LAYERED PROTECTIVE BAG WITH FILTER CARTRIDGES LOCATED INSIDE.



DUE TO THE PROTECTIVE BAG, THE LIQUID BEING FILTERED DOES NOT COME INTO CONTACT WITH THE HOUSING AND PROTECTS THE USER FROM DIRECT CONTACT WITH THE FLUID DURING FILTER CHANGEOUT.

PLEATED FILTER CARTRIDGES

PLEATED FILTER CARTRIDGES ARE SURFACE FILTERS FOR REMOVING HARD, NON-DEFORMABLE PARTICLES FROM A LIQUID STREAM. THEY FEATURE A LARGE FILTER AREA, A HIGH DIRT HOLDING CAPACITY AND CONSEQUENTLY A LONG FILTRATION LIFETIME.

The sharp cut-off characteristics created by the filter media ensures dependable and highly efficient particle removal at the designated micron rating. Pleated cartridges are therefore widely used as particle size classification filters, as well as being utilised as either final filters or as protection for expensive membrane filter cartridges.

TOP-PLEAT SERIES

The **Top-Pleat Series** is one of the finest ranges of pleated cartridges on market. Consisting of 4 layers of the highest quality filter media, they provide exceptional filter efficiency and lifetime. The constituent filter media has thermobonded fibres to prevent fibre and contaminant release.

The **Top-Pleat PP** is constructed from 100% polypropylene melt blown microfibre media and has a wide range of application suitability. Polypropylene is especially compatible with applications which require filter cartridge sterilisation with caustic soda. They are absolute rated at the designated micron rating (see table below).

The **Top-Pleat GF** is constructed from laboratory grade borosilicate (glass fibre) and incorporates polypropylene pre-filter and final filter layers. Borosilicate is a hydrophilic filter media, providing superior flow and lower pressure drops compared to polypropylene media. The 1 micron version is ideally suited to applications requiring Cryptosporidium and Giardia Cyst removal (certified to NSF/ANSI standard 53 for cyst reduction). Borosilicate has a natural charge (Z potential) to capture organic matter and retain colloids. **Top-Pleat GF** cartridges have an efficiency of 99.98% at the designated micron rating.

PARTICLE SIZE (µm)	PARTICLE REMOVAL EFFICIENCY (%) BY FILTER GRADE										
	0.1	0.2	0.45	1	3	5	10	20	30	50	100
0.1	95	93	82	80	30						
0.2	96	95	83	82	59						
0.45	98	97	96	94	82						
1	>98	98	97	96	86	47					
3	99	>98	98	97	97	90	30	29	28	26	
5	>99	>99	99	98	>97	97	57	56	55	54	
10			>99	99	>98	98	98	91	90	89	29
20				99	>98	>98	98	98	97	96	48
30				>99	99	99	>98	>98	98	97	89
50					>99	>99	99	>98	98	>97	94
100						>99	>99	99	>98	>98	98

- Surface area: 0.65m² per 10" length.
- 4 7/8" to 40" lengths.
- Modular construction.
- Standard I.D. 29.5mm O.D. 71mm.
- Available micron ratings:
Top-Pleat PP: 0.1 – 100.
Top-Pleat GF: 0.45, 1, 3, 5, 10.
- Polypropylene core and rigid outer cage.
- Thermally welded end caps.
- End fittings:
 Double open ended with flat gaskets, Code 3, Code 7, Code 8.
- Gasket materials:
 Nitrile, EPDM, Viton, Silicone, PTFE encapsulated Viton, PTFE encapsulated Silicone.
- Maximum recommended operating temperature 80°C.
- Maximum recommended differential pressure 2.75 Bar.
- Food grade version available.

TOP-PLEAT PP PRODUCT PERFORMANCE:

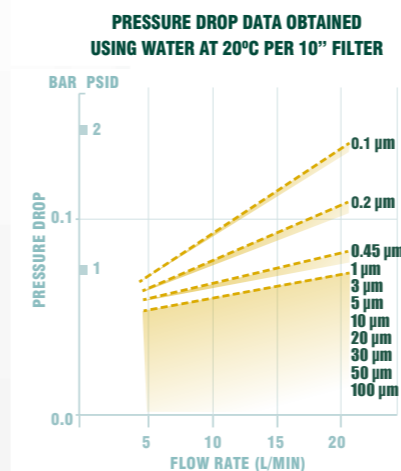

ECONOPLEAT PP:

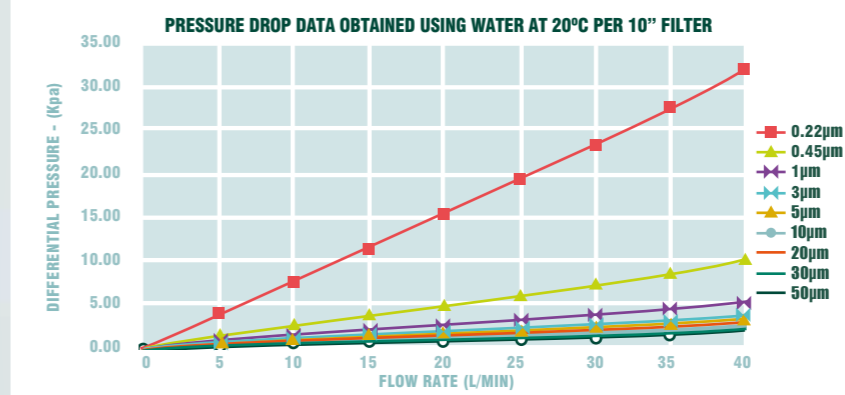

ECONOPLEAT SERIES

The Econopleat series of pleated cartridges consist of 3 layers of filter media, resulting in a high surface area cartridge that performs well with high flow rates, whilst achieving a good dirt holding capacity with no compromise to operational pressure drops.

ECONOPLEAT PP:

100% polypropylene melt blown filter media with thermally bonded end caps.

ECONOPLEAT GF:

Borosilicate media with polypropylene support layers with thermally bonded end caps.

ECONOPLEAT PE:

Polyester media with polypropylene end caps.

- Surface area: >0.34m² per 10" length.
- 4 7/8" to 40" lengths.
- Single piece construction.
- Standard I.D. 27.5mm O.D. 64mm.
- Large outer diameter 116mm versions available, 10" – 40".
- Available micron ratings (@ 95% efficiency):
 Econopleat PP: 0.2 - 50.
 Econopleat GF: 2, 5, 10, 20.
 Econopleat PE: 5, 10, 20, 50.
- Polypropylene core and polypropylene end caps (for all media).
- End fittings:
 Double open ended with flat gaskets, Code 3, Code 7, Code 8.
- Gasket materials: Nitrile, EPDM, Viton, Silicone, PTFE encapsulated Viton, PTFE encapsulated Silicone.
- Maximum recommended operating temperature 80°C.
- 2.75 Bar max dP

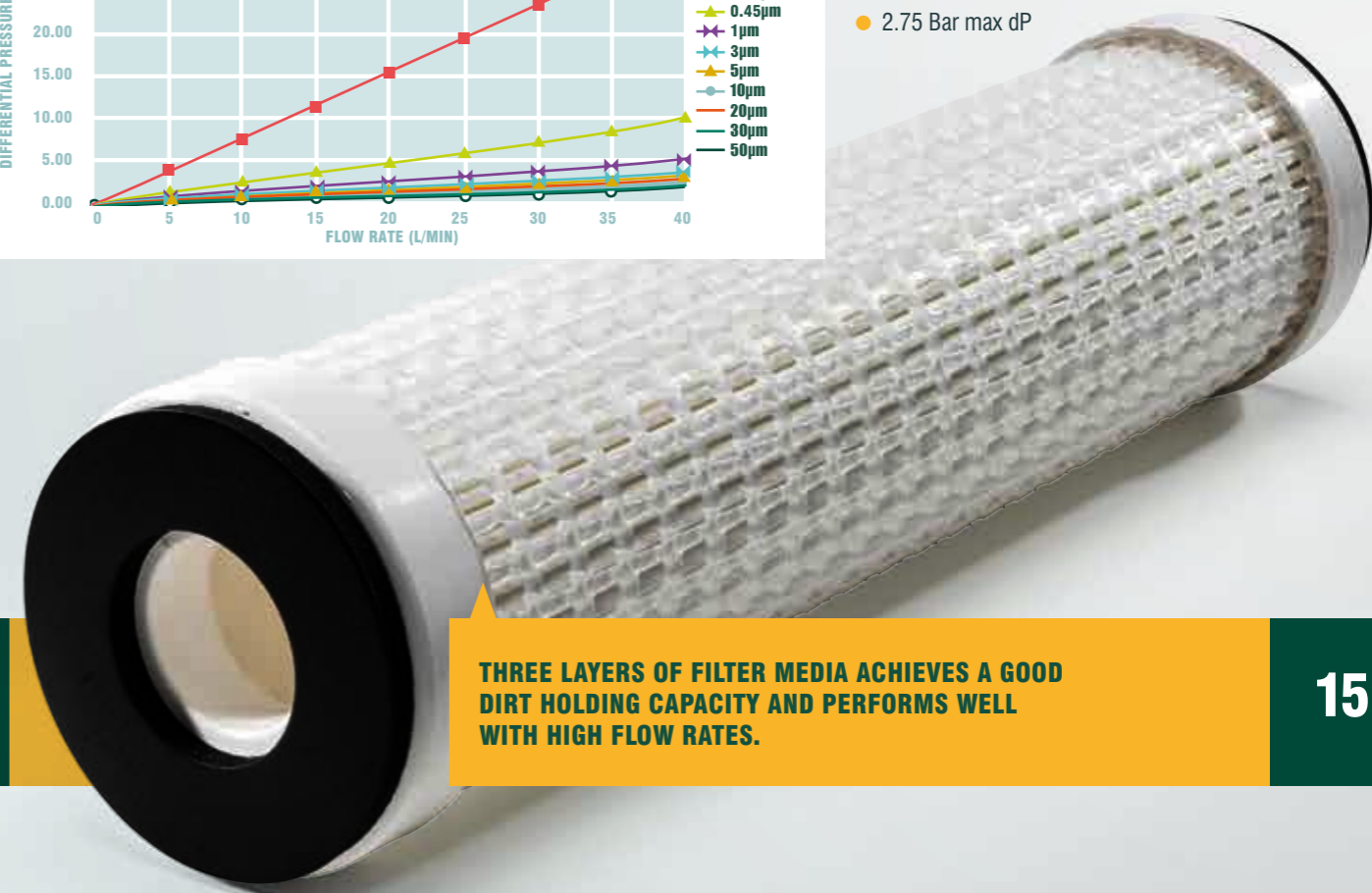

THREE LAYERS OF FILTER MEDIA ACHIEVES A GOOD DIRT HOLDING CAPACITY AND PERFORMS WELL WITH HIGH FLOW RATES.



MODULAR CONSTRUCTION WITH RIGID OUTER CAGE.

HIGH FLOW PLEATED CARTRIDGES

HIGH FLOW PLEATED CARTRIDGES COMBINE THE BEST OF PLEATED AND LARGE DIAMETER CARTRIDGES. THE UNIQUE MULTI-LAYERED CONSTRUCTION PROVIDES ABSOLUTE RATED PARTICLE RETENTION ACROSS A WIDE RANGE OF FLOW RATES WITH EFFICIENCIES OF 99.98% AT THE DESIGNATED MICRON RATING.

The large diameter yields much higher flow rates compared to traditional 2.5" diameter filters, permitting use of fewer elements and lowering capital expenditure.

Contrary to standard filter cartridges, high flow pleated filters most commonly have an inside to out liquid flow direction, enabling particles to be collected on the cartridge's interior. The cartridges have an injection moulded top end cap with integral moulded handle to assist cartridge removal.

- Polypropylene or borosilicate (glass fibre) filter media.
- Polypropylene support and drainage layers.
- Polypropylene core and end caps.
- Available micron ratings: 1 to 30.
- Standard lengths: 20", 40", 60".
- Outside diameter 152mm, inside diameter 74mm.
- Food contact compliant version available.
- Maximum recommended flow rate: 40m³/hr for 20" length. 80m³/hr for 40" and 60" lengths.
- Maximum recommended temperature: 80°C
- Maximum differential pressure: 4.8 Bar at 25°C, 2.1 Bar at 80°C.
- Recommended change-out pressure 2.4 Bar.
- Choice of seals: EPDM, Buna-N, Viton, Silicone.

ALLIED FILTER SYSTEMS LTD ALSO MANUFACTURES A RANGE OF SINGLE AND MULTI-ROUND FILTER HOUSINGS TO SUIT HIGH FLOW CARTRIDGE FILTERS. WE OFFER A CHOICE OF 2 CLOSURE TYPES : THE BOLTED LID CHHF SERIES OR THE V-CLAMP CLOSURE CHDHf SERIES. THE VESSEL INTERIOR FEATURES A HIGH OPEN AREA PERFORATED PLATE SUPPORT BASKET, AND BAYONET LOCKING SYSTEM TO ENSURE A POSITIVE SEAL FOR THE FILTER CARTRIDGE.

Manufactured from Stainless steel 304 or 316L, we offer both a horizontally mounted version for ease of cartridge change-out, or a vertically mounted version. The appropriate connection size and type can be specified in accordance with the needs of the application. The standard design is 10 Bar and 110°C rated, although higher pressure and temperature ratings are available on request. They can also be CE Marked and have ATEX certification.

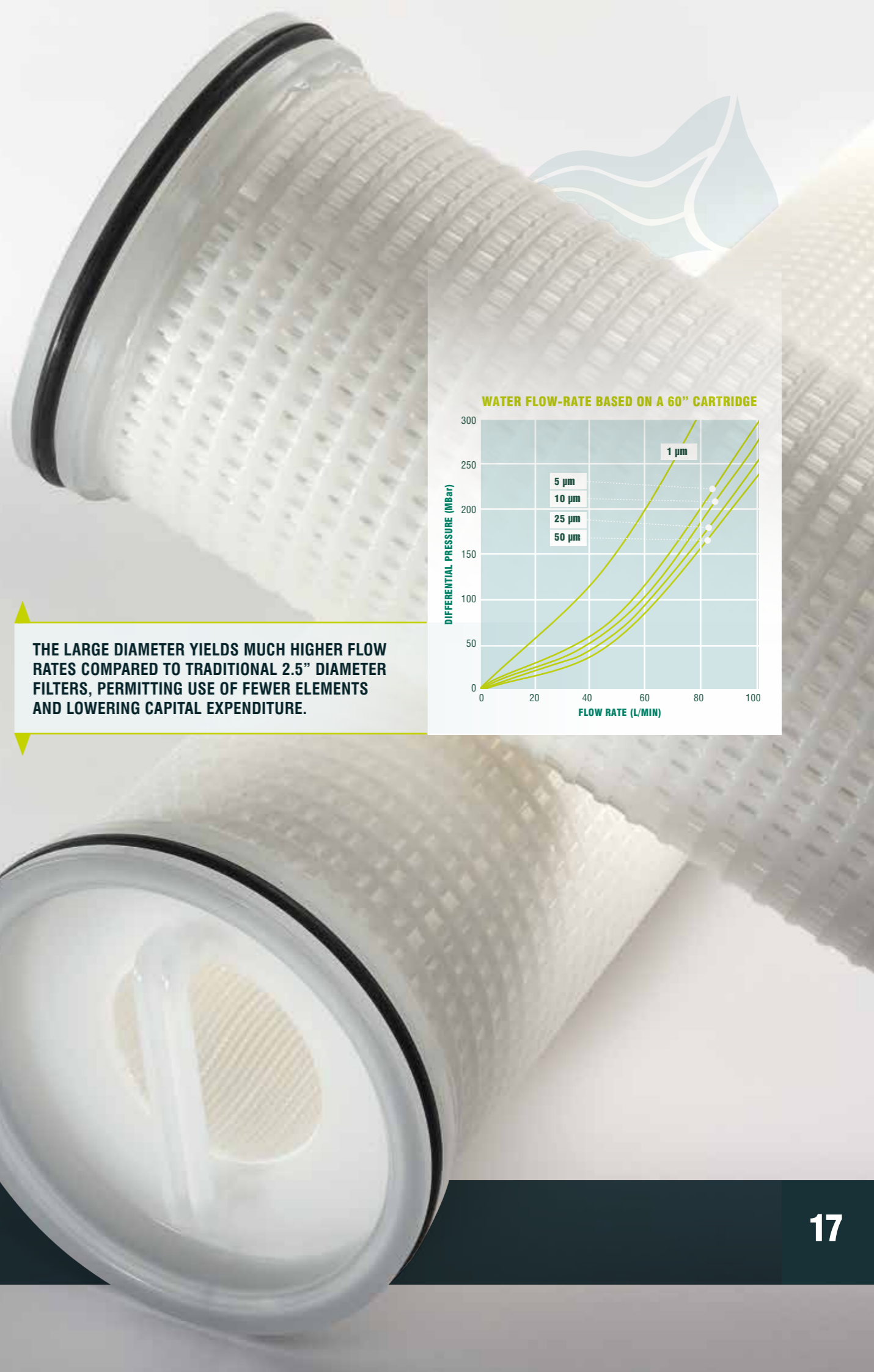
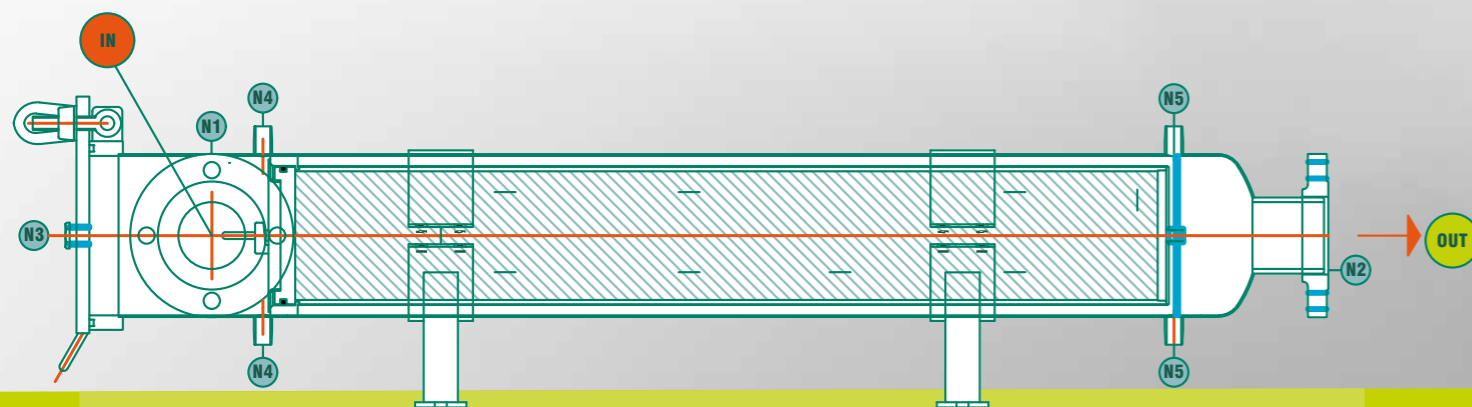

WATER FLOW-RATE BASED ON A 60" CARTRIDGE

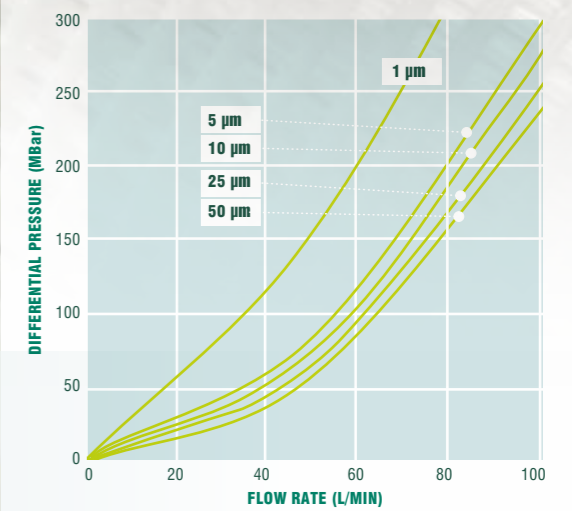

THE LARGE DIAMETER YIELDS MUCH HIGHER FLOW RATES COMPARED TO TRADITIONAL 2.5" DIAMETER FILTERS, PERMITTING USE OF FEWER ELEMENTS AND LOWERING CAPITAL EXPENDITURE.



ALL FILTER CARTRIDGES AND FILTER HOUSINGS ARE MANUFACTURED TO ISO 9001 QUALITY STANDARDS.

MULTIFINE SERIES

PLEATED CARTRIDGE

THE MULTIFINE SERIES PLEATED FILTER CARTRIDGE IS DESIGNED TO FIT INTO INDUSTRY STANDARD FILTER BAG HOUSINGS (SEE SEPARATE BROCHURE) WITHOUT THE NEED FOR ANY MODIFICATION TO THE EXISTING EQUIPMENT. THE HIGH SURFACE AREA PROVIDES A HIGH FLOW RATE AND DIRT HOLDING CAPACITY WITH A LOW PRESSURE DROP.

Available to suit size 1 and 2 vessels, Multifine cartridges are manufactured from melt blown polypropylene, polyester or borosilicate filter media. The cartridge features polypropylene end caps and an outer cage which provides mechanical support for the filter media. A choice of gaskets is available to meet the chemical compatibility needs of the application.

FITS INTO INDUSTRY STANDARD BAG FILTER VESSELS WITHOUT THE NEED FOR EQUIPMENT MODIFICATIONS.

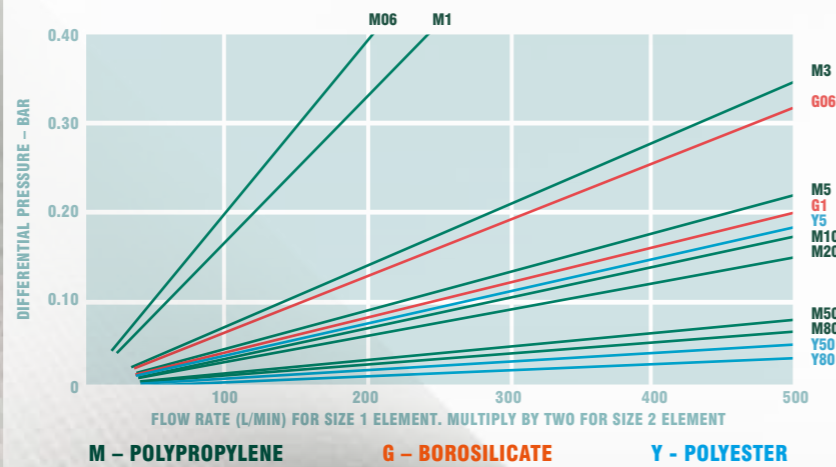

PES MEMBRANE

PES SYMMETRIC AND PES XL SERIES

POLYETHERSULPHONE MEMBRANE FILTER CARTRIDGES ARE DESIGNED TO PROVIDE RELIABLE STERILIZING FILTRATION FOR A WIDE VARIETY OF APPLICATIONS INCLUDING WATER FILTRATION, REMOVAL OF SPOILING MICRO-ORGANISMS IN BEVERAGES, AND FILTRATION OF PHARMACEUTICAL PRODUCTS.

Stringent quality control standards assure effective, consistent filtration performance and controlled pore sizes. PES membranes are inherently hydrophilic, and can therefore operate at high flow rates with a low differential pressure. Polypropylene support layers are present to provide mechanical strength and additional contaminant holding capacity.

The **PES Symmetric Series** consists of a single layer symmetric PES membrane. The **PES XL Series** consists of a single layer highly asymmetric membrane, providing a superior dirt holding capacity and therefore longer service life.

A special construction double layer version is also available on request consisting of a layer of symmetric and a layer of asymmetric membrane.

PES membrane cartridges are available with or without integrity testing prior to final packing depending on the needs of the application, and meet the requirements of FDA regulation CFR 177-82, USP Class VI, and EC food contact directives.

- Available micron ratings:
PES Symmetric: 0.1, 0.22, 0.45.
PES XL: 0.1, 0.22, 0.45, 0.65, 0.8, 1.2.
- Polypropylene support core.
- Available from 10"– 40" (5" version available for PES XL).
- Effective filtration area 0.58m²/10".
- Range of configurations including double open ended, Code 7, Code 8 and Code 3. Available gaskets include O-rings include Silicone, EPDM and Viton.
- Can be provided with PBT or stainless steel inserts.
- Maximum operating temperature: 80°C.
- Maximum differential pressure: 4.0 Bar at 21°C, 2.4 Bar at 70°C.
- Bubble point:
>0.34 MPa (water) 0.22 micron,
>0.22 MPa (water) 0.45 micron.

- Diffusion Flow:
<30ml/min/10" @0.25MPa (water) 0.22 micron,
<28ml/min/10" @0.16MPa (water) 0.45 micron.
- Steam sterilization:
PES Symmetric: ≥ 200 cycles (135°C/30min @ Max dP 0.3 Bar)
PES XL: ≥ 100 cycles (121°C/30min @ Max dP 0.3 Bar).
- Hot water sterilization:
85°C/30 min @ Max dP 2 Bar.
- Cleaning solution:
2% NaOH Solution @ ≤ 65°C.
- Bacterial challenge test with B.diminuta bacteria.

FLOW RATE CHARACTERISTICS

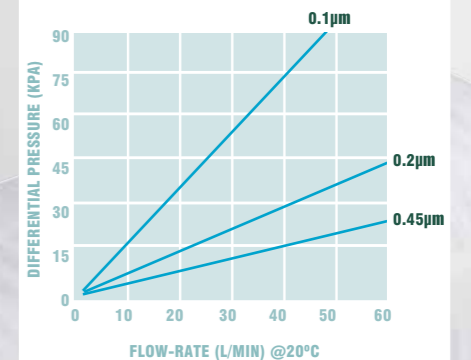

RELIABLE MICROBIOLOGICAL CONTROL

The primary purpose of this membrane filter cartridge in beverage filtration is to effectively remove product spoiling microorganisms.

TYPICAL LOG REDUCTION VALUE (LRV)

	B. diminuta	Lactobacillus Brevis	Sasharomyces Cerevisiae
0.1µm	>7/cm ²	N/A	N/A
0.2µm	>7/cm ²	N/A	N/A
0.45µm	N/A	>7/cm	N/A
0.65µm	N/A	>4/cm ²	>7/cm ²
1.2µm	N/A	N/A	>7/cm ²

Log reduction Values are calculated using the following formula:
LRV = log₁₀ ($\frac{\text{total number of organisms entering the filter}}{\text{total number of organisms exiting the filter}}$)

CARBON CARTRIDGES

ECB AND SCB SERIES

THE ECB SERIES USES THE LATEST CARBON MANUFACTURING TECHNIQUES MAKING IT THE ECONOMIC CHOICE FOR A WIDE RANGE OF INDUSTRIAL WATER APPLICATIONS.

The ECB is ideally suited to processes where the life of the carbon is never fully utilised. ECB series cartridges are manufactured from acid washed industrial grade bituminous granular activated carbon (GAC) extruded into a carbon block format.

The SCB series is manufactured using fine, acid washed, bituminous powder activated carbon (PAC), greatly increasing surface area and cartridge life. Food grade additives are used to bond the PAC, enabling the SCB series to be suitable for drinking water applications.

Extruded from high quality carbon fines, the SCB has a much higher adsorption capacity, extending life and improving chlorine reduction capacities compared to the ECB series. The result is a highly efficient carbon cartridge with sediment filtration capabilities.

- Constructed with an outer polypropylene wrap that protects and extends the life of the carbon block, capturing particles and preventing premature blinding.
- 9¾" and 40" lengths. Standard I.D. 28 mm, O.D. 64mm.
- Available in large diameter 116mm, 9¾" and 20" lengths for reduced cartridge changeout frequency.
- ECB series: 1, 5 and 10 micron.
SCB series: 5,10 micron.
- Double open ended.
- Maximum operating temperature 82°C.
- 2.5 Bar maximum dP

ECB

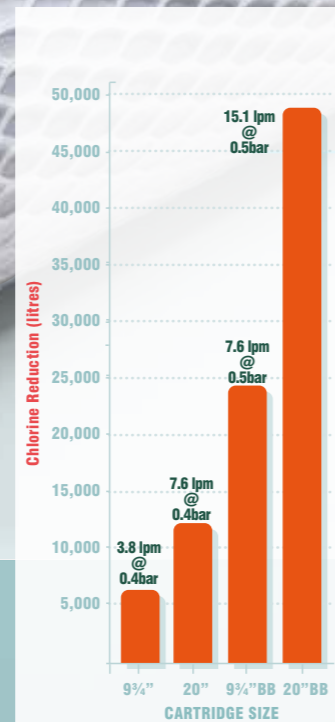

SCB

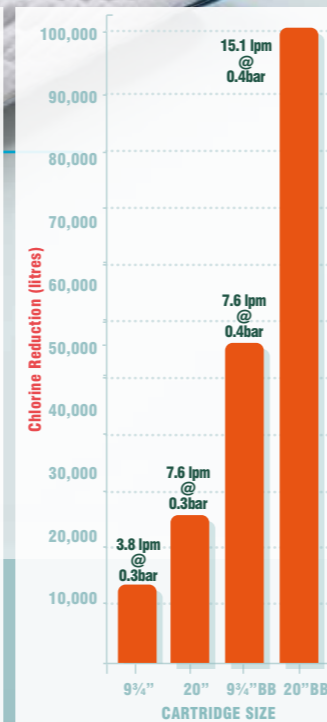

DUO CARBON (DC) SERIES

The Duo Carbon (DC) series filter cartridge is effective at reducing the chlorine taste and odour from drinking water.

The Duo Carbon features a first stage wound polypropylene pre-filter to capture sediment and other impurities, the second stage utilises the highest quality carbon for water treatment, and a final 5 micron filter sleeve captures suspended carbon fines before they exit the filter. The Duo Carbon series therefore has the benefit of a two in one process, eliminating the need for a pre-filtration step.

- Choice of granulated coal or granulated coconut shell carbon (both can have optional silver impregnation to inhibit bacteria growth), or cellulose carbon paper.
- 10" - 40" lengths. Standard I.D. 28 mm, O.D. 64mm.
- Pre-filtration layers 1 - 50 micron. Final 5 micron filtration layer.
- Choice of end fittings including Double open ended, Code 3, Code 7 or Code 8.
- Maximum operating temperature 80°C.
- 2.5 Bar maximum dP

MULTI-STAGE CONSTRUCTION ENABLES BOTH PARTICLE RETENTION AND WATER TREATMENT IN A SINGLE CARTRIDGE.

CARBON WRAP (CW) SERIES

The Carbon Wrap (CW) series features powder activated carbon (PAC) impregnated into a cellulose fibre media, removing sediments and other fine particulates throughout its depth. The CW series combines the advantages of both a high dirt-loading depth cartridge with the odour, discoloration and chlorine reduction capabilities of PAC.

The carbon impregnated sheet is wrapped around a polypropylene support core, supported by an outer layer of polyethylene netting.

- 9 ¾" - 40" lengths. Standard I.D. 28 mm, O.D. 64mm.
- Available in large diameter 116mm 9¾" and 20" lengths for reduced cartridge change out frequency.
- Rating: 5 micron.
- End caps: Double open ended with EPDM gaskets, Code 3, Code 7 or Code 8.
- Maximum operating temperature 80°C.
- 2.5 Bar maximum dP

CARBON WRAP

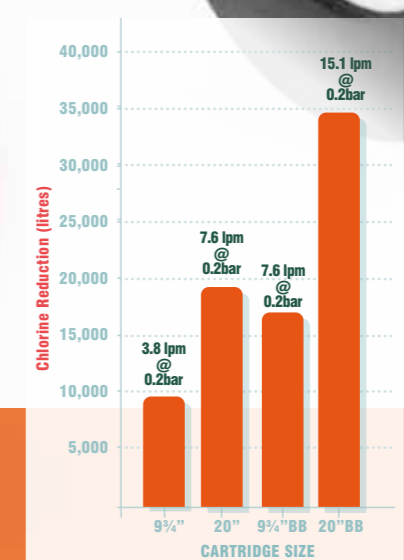

OIL ABSORBENT FILTER CARTRIDGES

OUR RANGE OF OIL ABSORBENT FILTER CARTRIDGES HAVE BEEN DEVELOPED FOR APPLICATIONS REQUIRING REMOVAL OF HYDROCARBONS FROM WATER AS A POLISHING FILTER AFTER COALESCING OR FOLLOWING OTHER BULK REMOVAL METHODS. IT IS RECOMMENDED FOR APPLICATIONS WITH <500PPM TOTAL HYDROCARBONS, AND HAS A RETENTION OF 99%.

Oil absorbent cartridges are constructed from an impregnated media consisting of fibres that have a unique coating thermally bonded within the structure.

Using the standard media, flow is not effected and no hydrocarbons are released. The filter media will absorb 3 times its weight before change out is required.

As an option, our 'Plus' media will build up a differential pressure and flow will be reduced as the cartridge absorbs hydrocarbons.

Alternatively our 'Block' media forms an instant barrier when in contact with hydrocarbons, and can be used for final stage oil removal where no oil in water monitors are present.

- Available 9 3/4" to 60" length.
- Standard O.D. 70mm. (Optional large 116mm diameter) I.D. 27.5mm.
- Standard construction is with a Polypropylene core.
- Available with industry standard end caps.

- O-rings for end caps include Nitrile, EPDM, Silicone, Viton, PTFE encapsulated Viton, PTFE encapsulated Silicone.
- Stainless steel core and caps available for more demanding applications.
- Maximum operating temperature 80°C.
- Food grade version available.



METALLIC FILTER CARTRIDGES

METALLIC FILTER CARTRIDGES ARE A RE-USABLE SURFACE FILTER MANUFACTURED USING STAINLESS STEEL WIRE MESH FILTER MEDIA.

They are designed to withstand demanding working conditions as well as strong cleaning procedures such as backwash or chemical treatment. They can also be cleaned in an ultrasonic bath, with high pressure water or by simply brushing the surface of the wire mesh.

Stainless steel has a wide chemical compatibility, and use at high temperature can be achieved in relation to the material joining the end cap. Their low pressure loss also makes them suitable for use with high viscosity fluids.

Our range has two construction options, either non-pleated or pleated which provides enhanced surface area and filter lifetime.

- Stainless steel 304 or 316.
- 10" to 40" lengths.
- Available micron ratings: 10, 25, 40, 70, 100, 150, 250, 300, 400, 750.
- End fittings: Double open ended with flat gaskets, code 3, Code 7, Code 8.
- Standard O.D. for all end cap configurations: 65 mm

- Standard I.D.: Double open ended – 26mm Code 7 – 36mm Code 8 – 33mm
- Gasket materials: Nitrile, EPDM, Viton, Silicone, PTFE.

MAXIMUM WORKING TEMPERATURE IN RELATION TO METHOD OF JOINING END CAP.

EPOXY/SS END CAPS	PRESSED SS END CAPS	TIN JOINT/ SS END CAPS	POLYPROPYLENE END CAPS	INTEGRALLY WELDED SS END CAPS
130°C	300°C	190°C	80°C	400°C



OIL ABSORBENT FILTER MEDIA WILL ABSORB THREE TIMES ITS WEIGHT BEFORE REQUIRING CHANGE OUT.

RE-USABLE SURFACE FILTERS MANUFACTURED USING STAINLESS STEEL WIRE MESH MEDIA.